

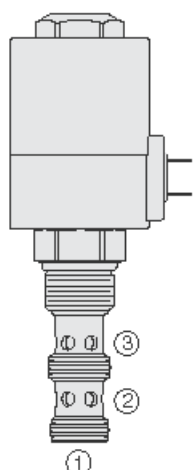

Overview



Description

This is a solenoid operated, two position, three way, direct acting spool valve. It is intended for use in mineral based or synthetic (with lubrication properties) hydraulic fluids as a bidirectional selector valve.

Features

- Bidirectional operation.
- Continuous-duty rated coil.
- Hardened precision spool and cage for long life.
- Optional coil voltages and terminations.
- All ports may be fully pressurized.
- Heavy-duty waterproof E&E Coils rated up to IP69K.

Symbol

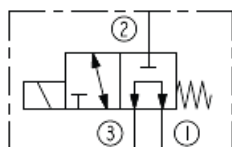

Ratings

Pressure Ratings

Pressure rating	241 bar (3500 psi)
Proof pressure	483 bar (7000 psi)
Burst pressure	690 bar (10000 psi)

Flow Ratings

Flow rating	- Note: See performance chart	
Maximum internal leakage	410 ml/min (25 in ³ /min)	- Note: Max at 240 bar (3500 psi); per NFPA/t 3.5.15m-1986

Other Ratings

Cycle life	One million cycles	
Response	45 ms	- Note: Pull-in, indication of shift with nominal voltage
	20 ms	- Note: Drop-out, indication of shift with nominal voltage
	100 ms	- Note: Pull-in, per NFPA/T3.5.30-19XX
	100 ms	- Note: Drop-out, per NFPA/T3.5.30-19XX

Temperature Ratings

Operating fluid temperature	-40 to 100 °C (-40 to 212 °F)	- Note: With buna N seals
	-26 to 204 °C (-15 to 400 °F)	- Note: With fluorocarbon seals
Storage temperature	-40 to 70 °C (-40 to 160 °F)	
Ambient temperature	-40 to 70 °C (-40 to 160 °F)	

Operating Parameters

Fluids	Mineral based or synthetic hydraulic fluid with lubricating properties	
Fluid viscosity range	7.4 to 420 cSt	
Maximum operating contamination level	20/18/14 per ISO 4406	

Properties

Unit weight	0.39 kg (0.87 lb)	- Note: Std. valve
Internal wetted surface area	339 cm ² (52.5 in ²)	



Performance

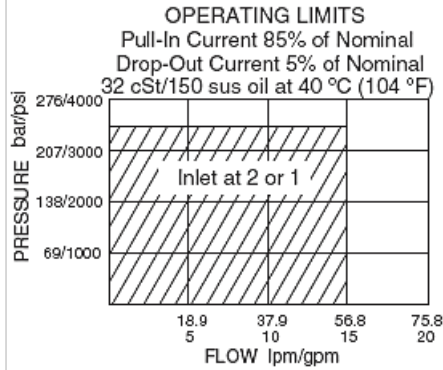
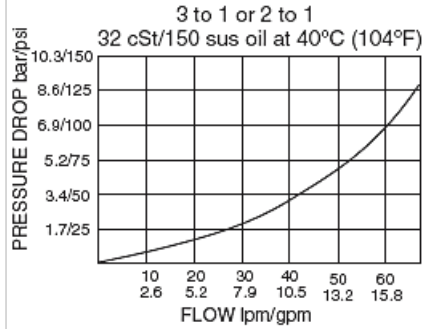
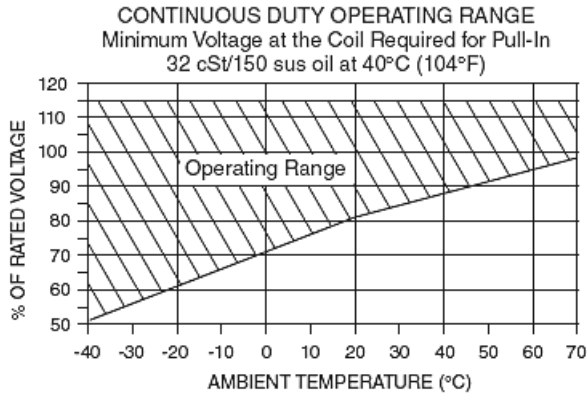

Dimensions

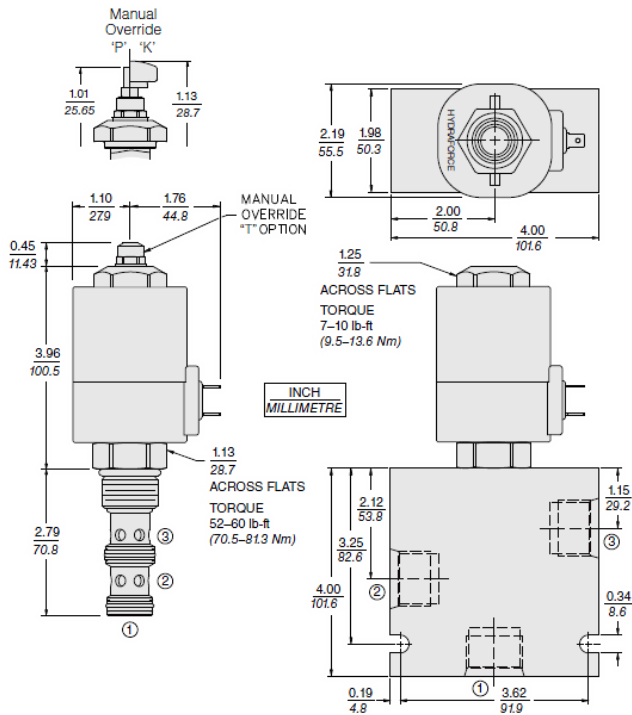

Installation Specifications

Cavity	VC12-3
Cartridge installation torque	70.5 to 81.4 N-m (52 to 60 ft-lb)
Maximum allowable torque	102 N-m (75 ft-lb)
Coil nut torque	9.5 to 13.6 N-m (7 to 10 ft-lb)
Orientation restriction	None



Accessories

Seal kit SK12-3X-MM - **Note:** X = seal option
Housings
Coils



Order Code

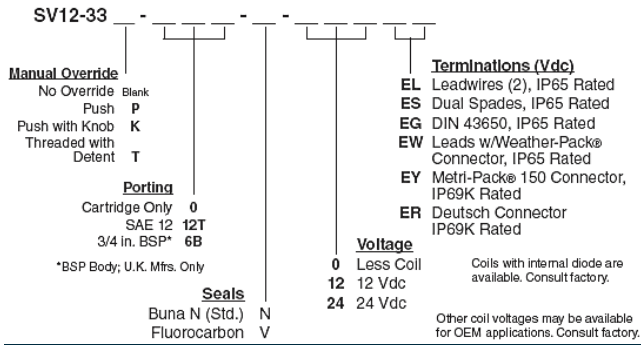

POSITION	CODE	DESCRIPTION
		SV12-33E-H-J-L
E		Manual Override
E	BLANK	NONE
E	K	Momentary Push Override, Knob
E	P	Momentary Push Override, Button
E	T	Variable Position Override, Slotted Screw
H		Line Body
H	0	No Body
H	8T	Aluminum SAE 8
H	10T	Aluminum SAE 10
H	12T	Aluminum SAE 12
H	12TD	Ductile Iron SAE 12
H	6B	Aluminum BSPP 3/4" (6)
J		Seal
J	N	Buna-N
J	V	Fluorocarbon
J	P	Polyurethane
J	U	PPDI Urethane
L		Coil
L	0	No Coil
L	12EG	12 VDC, E-Coil, DIN 43650
L	12EL	12 VDC, E-Coil, Dual Lead Wires
L	12EL/W	12 VDC, E-Coil, Dual Lead Wires with WeatherPak
L	12ER	12 VDC, E-Coil, Deutsch
L	12ER/Z	12 VDC, E-Coil, Deutsch with Zener Diode
L	12ES	12 VDC, E-Coil, Dual Spade
L	12EY	12 VDC, E-Coil, Metri-Pack 150
L	24EG	24 VDC, E-Coil, DIN 43650
L	24ER	24 VDC, E-Coil, Deutsch
L	24ER/Z	24 VDC, E-Coil, Deutsch with Zener Diode
L	24ES	24 VDC, E-Coil, Dual Spade